

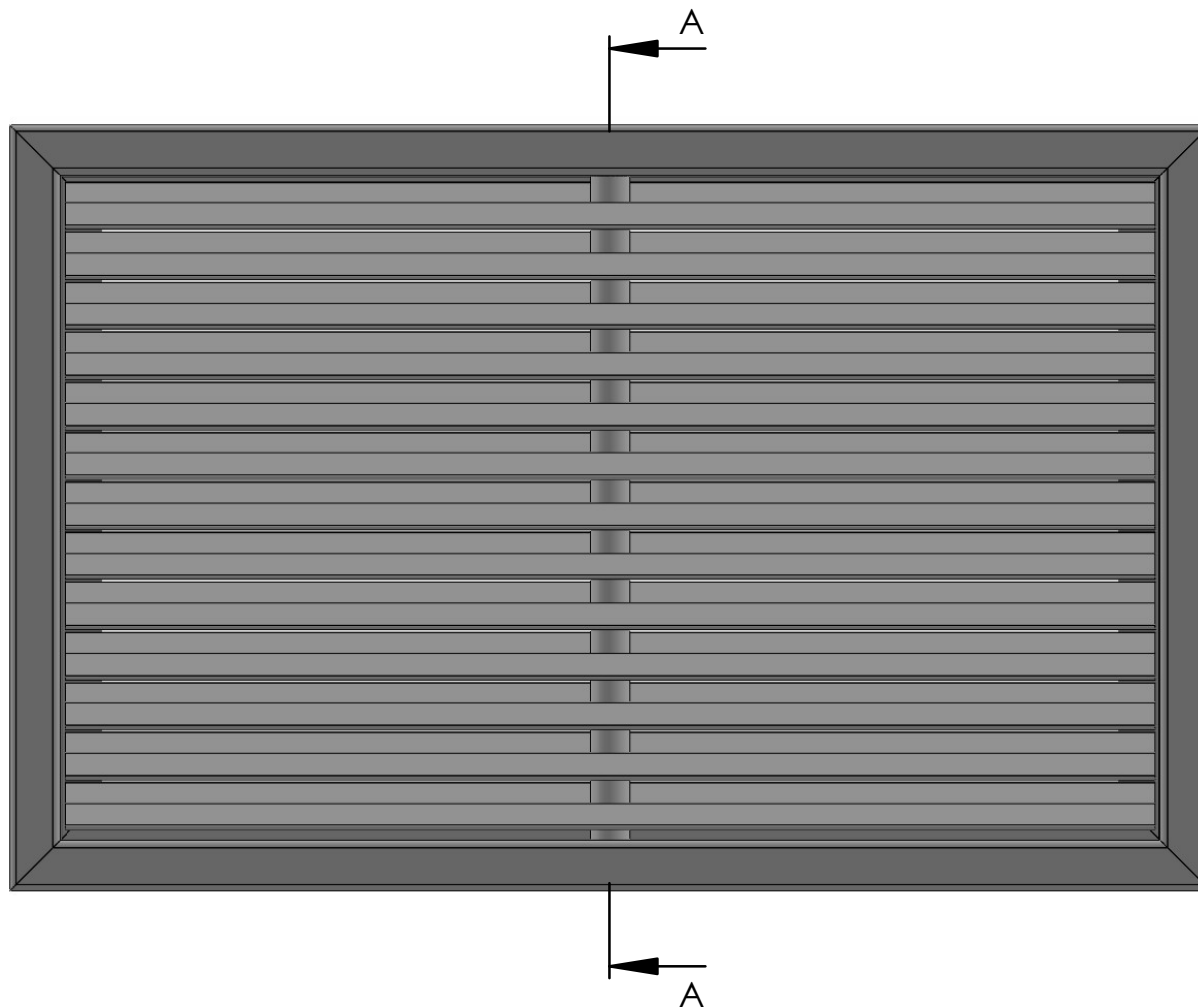

VENTILATIE

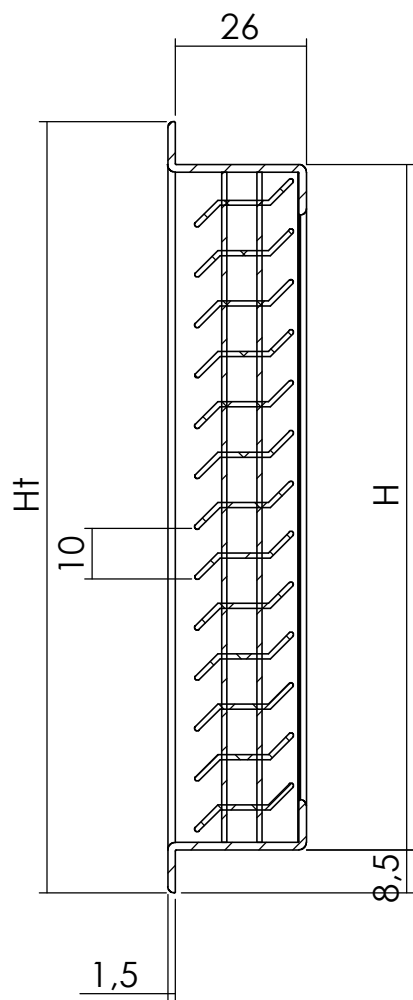

CONCEPTS

	Naam	Handtekening	Datum	Materiaal:	Naam tekening:
Getekend	T. Doornhein		2-12-2020		SG57
Gecontroleerd				Gewicht:	Tolerantie: Volgens GAVO AT01
Goedgekeurd				SCALE:1:1.2	A4 SHEET 1 OF 1



						
	Naam	Handtekening	Datum	Materiaal:	Naam tekening:	
Getekend	Ing. T. Doornhein		2-12-2020		SG57B	
Gecontroleerd				Gewicht:	Tolerantie: Volgens GAVO AT01	A4
Goedgekeurd						

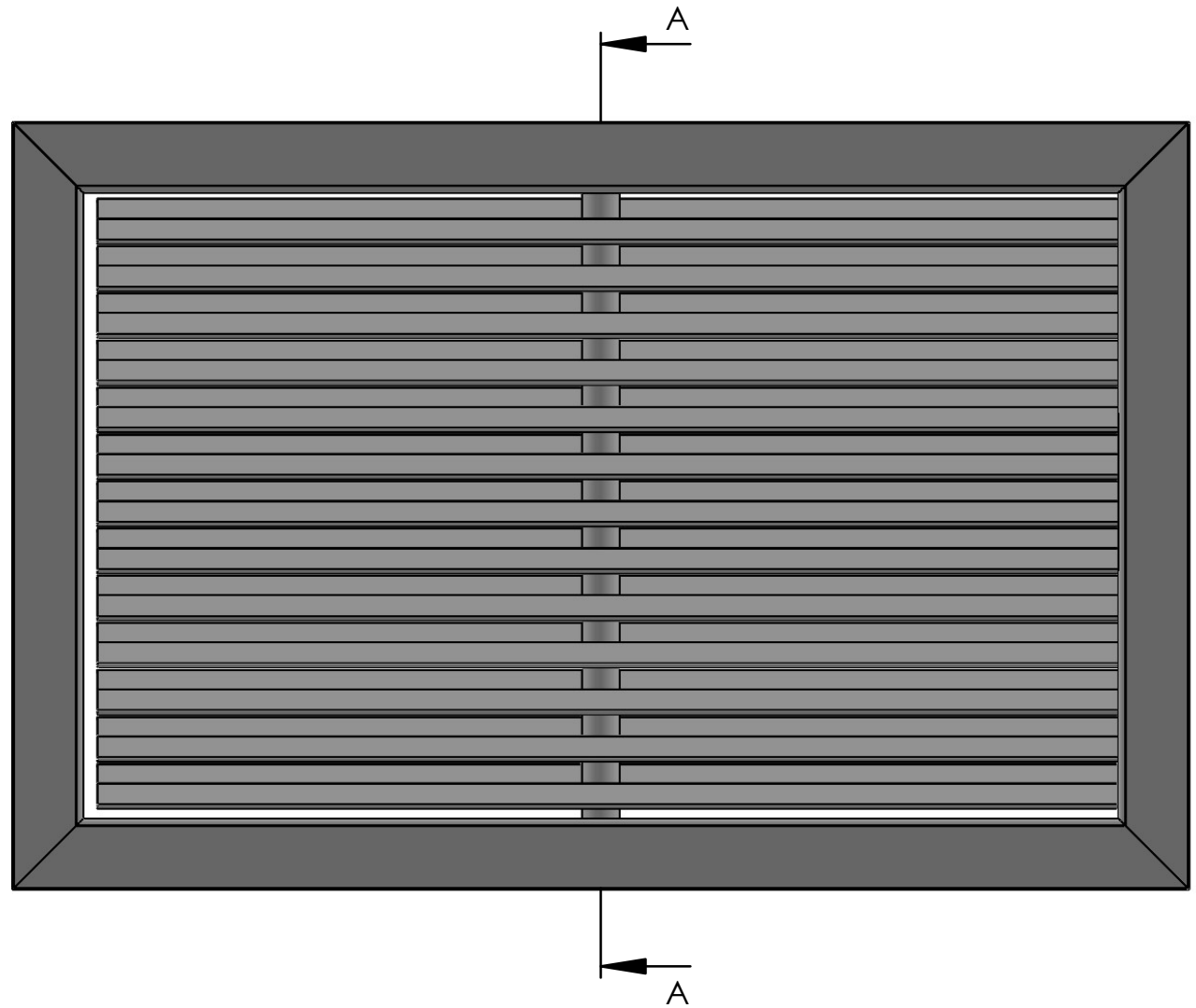
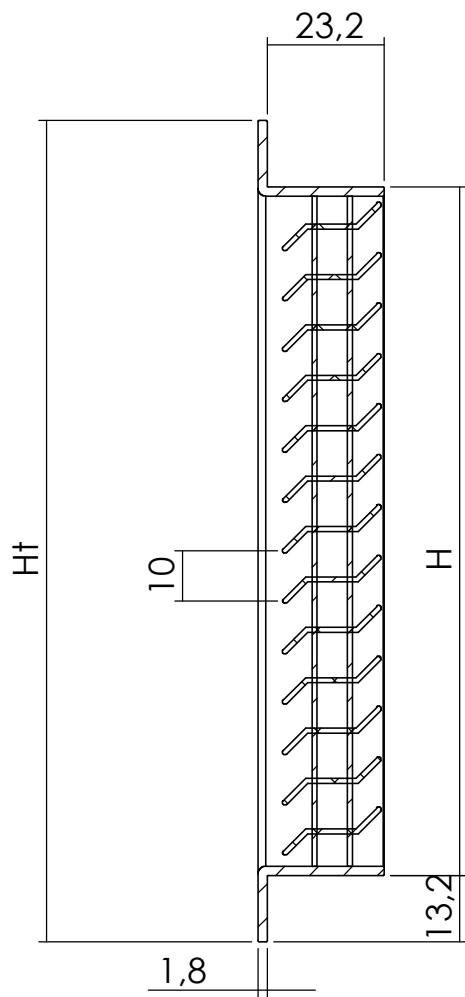

GAVO VENTILATIE

GAVO CONCEPT

	Naam	Handtekening	Datum	Materiaal:	Naam tekening:
Getekend	T. Doornhein		2-12-2020		SG75C
Gecontroleerd				Gewicht:	Tolerantie: Volgens GAVO AT01
Goedgekeurd				SCALE:1:1.5	A4 SHEET 1 OF 1

SGX-KVS

Set: 4x

For Frametype A and C

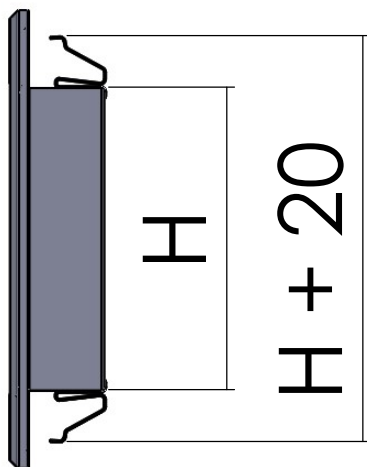
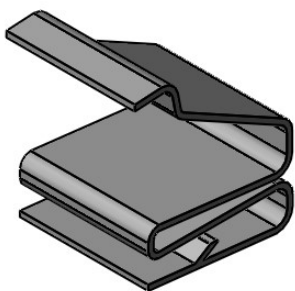

GAVO VENTILATIE

GAVO CONCEPTS

	Naam	Handtekening	Datum	Materiaal:	Naam tekening: SGX-KVS	
Getekend	Ing. T. Doornhein		7-2-2020	Gewicht:	Tolerantie: Volgens GAVO AT01	A4
Gecontroleerd				SCALE:1:2	SHEET 1 OF 1	
Goedgekeurd						