

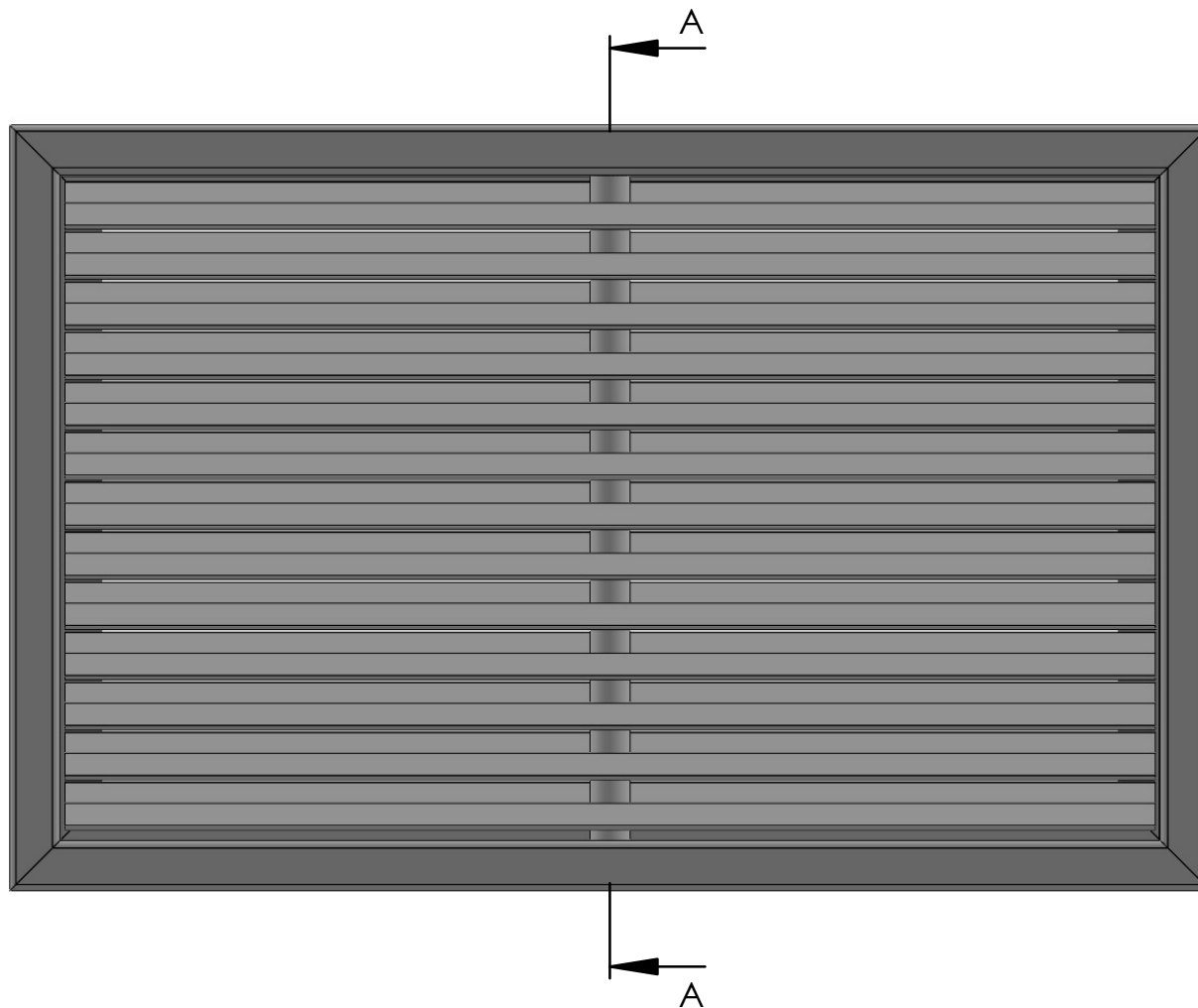

**VENTILATIE**

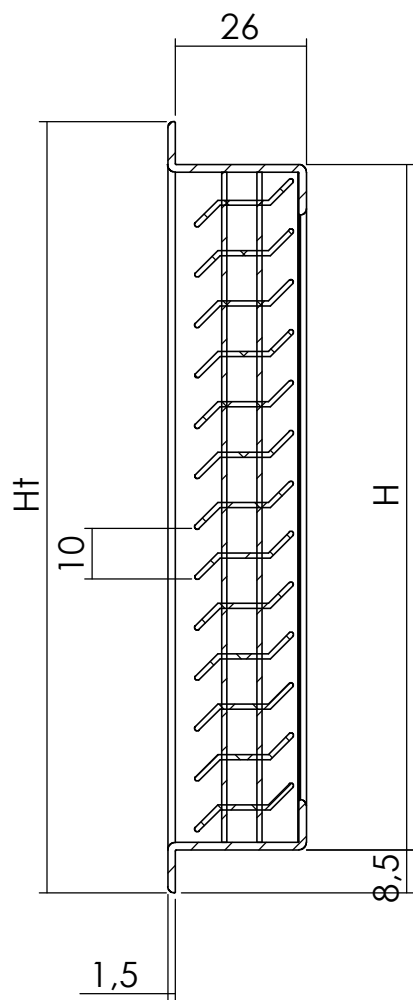

**CONCEPTS**

	Naam	Handtekening	Datum	Materiaal:	Naam tekening:
Getekend	T. Doornhein		2-12-2020		<b>SG57</b>
Gecontroleerd				Gewicht:	Tolerantie: Volgens GAVO AT01
Goedgekeurd				SCALE:1:1.2	A4 SHEET 1 OF 1



 <b>GAVO VENTILATIE</b>		 <b>GAVO CONCEPT</b>				
	Naam	Handtekening	Datum	Materiaal:	Naam tekening:	
Getekend	Ing. T. Doornhein		2-12-2020		<b>SG57B</b>	
Gecontroleerd				Gewicht:	Tolerantie: Volgens GAVO AT01	A4
Goedgekeurd						

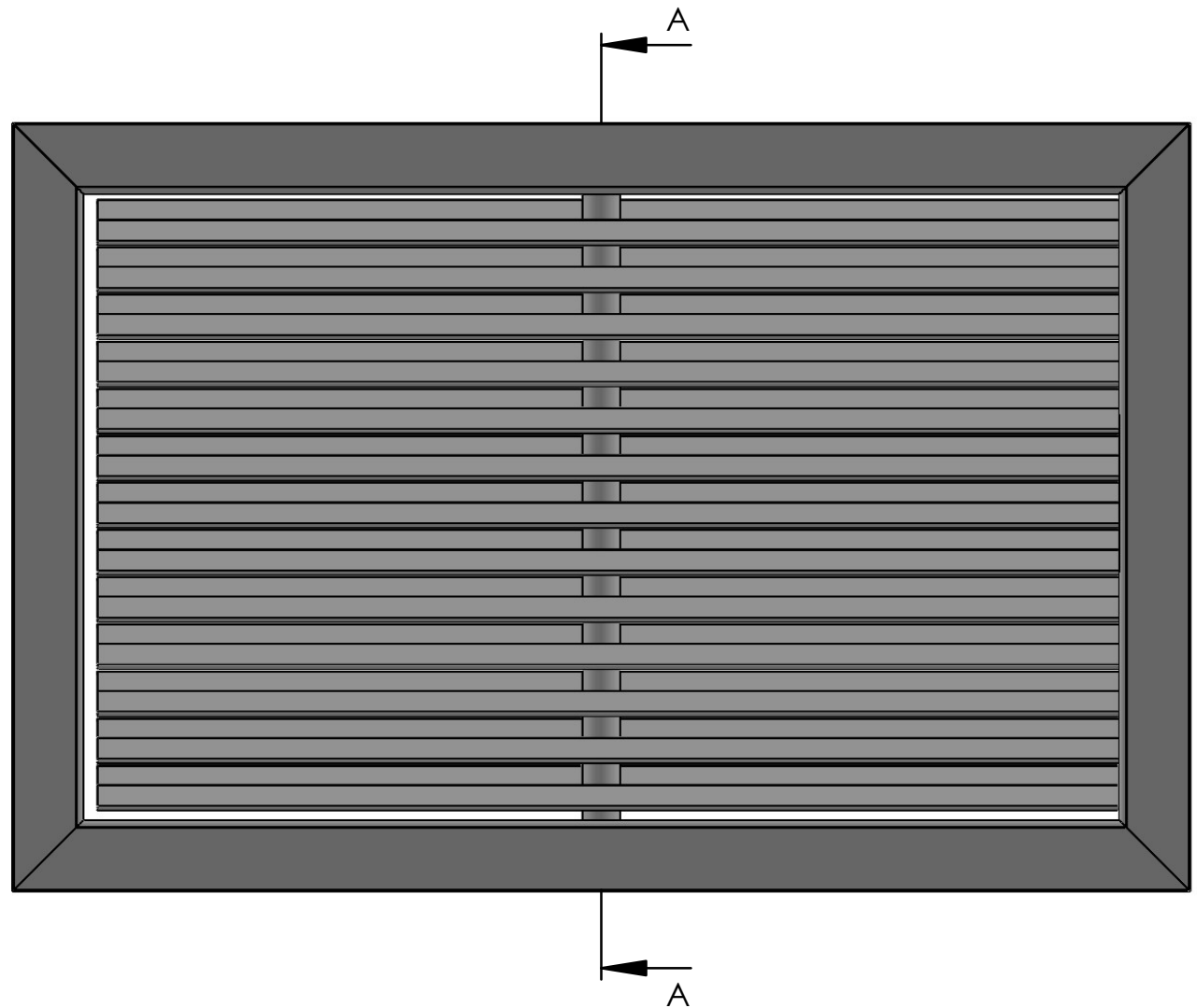
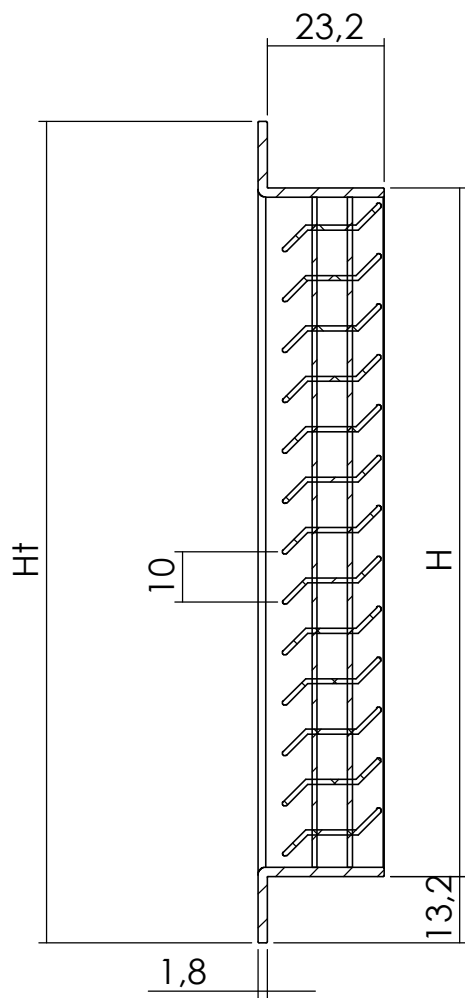

**GAVO VENTILATIE**

**GAVO CONCEPT**

	Naam	Handtekening	Datum	Materiaal:	Naam tekening:
Getekend	T. Doornhein		2-12-2020		<b>SG75C</b>
Gecontroleerd				Gewicht:	Tolerantie: Volgens GAVO AT01
Goedgekeurd				SCALE:1:1.5	A4 SHEET 1 OF 1

# SGX-KVS

## Set: 4x

### For Frametype A and C

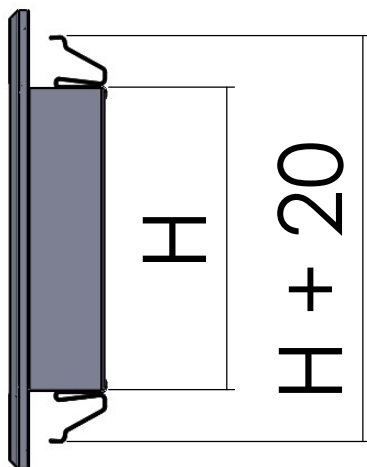
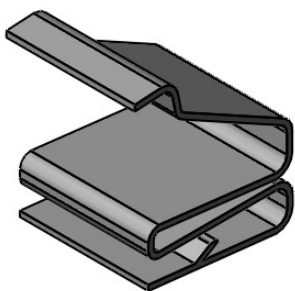

**GAVO VENTILATIE**

**GAVO CONCEPTS**

	Naam	Handtekening	Datum	Materiaal:	Naam tekening:
Getekend	Ing. T. Doornhein		7-2-2020		<b>SGX-KVS</b>
Gecontroleerd				Gewicht:	Tolerantie: Volgens GAVO AT01
Goedgekeurd				SCALE:1:2	A4 SHEET 1 OF 1